

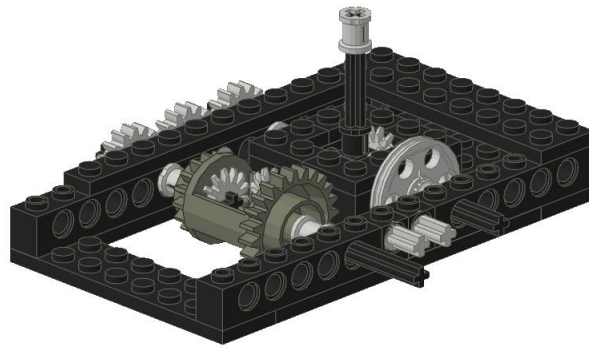

11

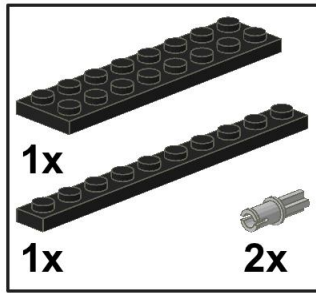

12

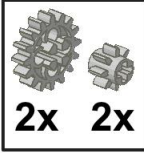

2x 2x

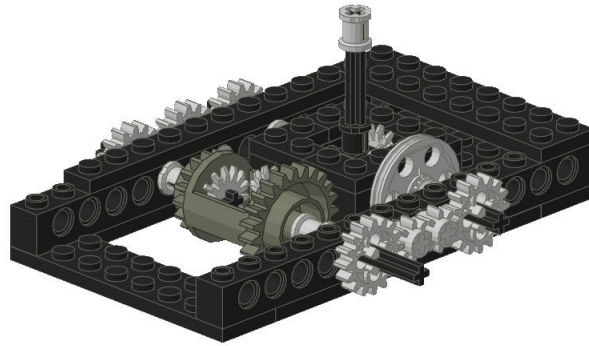

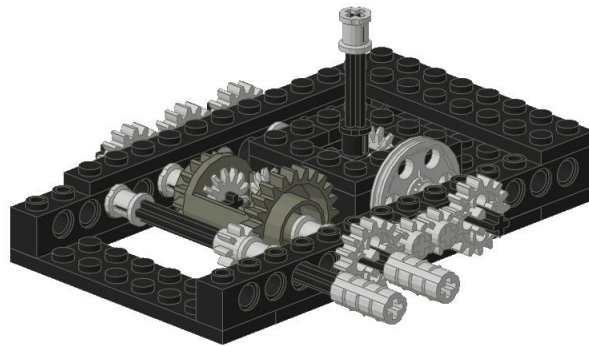
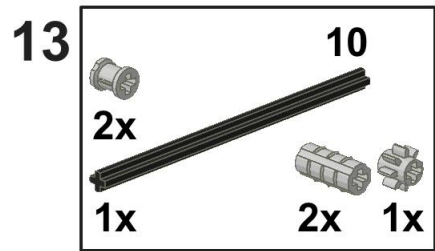

14

